

legris

connectic

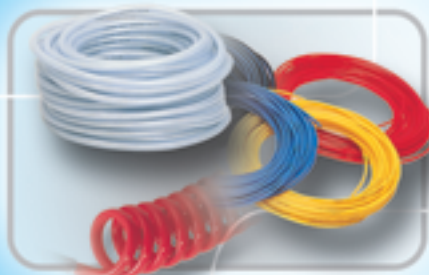



**Connection solutions
for industrial fluids**

Product Guide

This product guide is a representative overview of the Legris low pressure offer. Find out more in Legris **general catalogue** and on the web site **www.legris.com**

Legris, a member of Group Legris Industries, designs, manufactures and markets innovative solutions for connecting, conveying and controlling industrial fluids. Inventor and leader in low pressure instant connection, Legris has based its development and success on essential strategic **customer-focused values**.

To meet current and future industrial requirements

Legris Connectic works closely with companies that are present in **all industrial fields** and offers a **wide range of products and services** in order to meet the requirements of various sectors: assembly and packaging machines, automation, food liquid circuits, automotive process, etc.

Legris adopts an ongoing strategy of research and product innovation, in order to offer a continuous range of **new solutions** and wider applications to its customers.

Legris is certified **ISO 9001 : 2000**.



To be close to you in order to serve you better

With 25 sales subsidiaries, 10 industrial and logistic locations and a network of distributors and agents, Legris Connectic is **present in 76 countries**. This worldwide presence enables Legris to better identify the changes and specific requirements of each market, in order to offer the best solutions, whilst meeting **local standards**.

A genuine sales and technical relay team ensures that there is a **close relationship** with each local market, providing it with support, advice and product logistics.



European directives ROHS, ELV and WEEE

Legris has always encouraged the use of non dangerous substances (heavy metals, bromine derivatives) in the design of its products in order to protect the **environment** and to safeguard **public health**. Thus, every effort has been made to ensure that **concerned ranges** would respect European directives **ROHS** (Reduction of Hazardous Substances - 2002/95/CE), **ELV** (End of Vehicle Life - 2000/53/CE) and **WEEE** (Waste Electrical and Electronic Equipment- 2002/96/CE), by 1st July 2006.

Additional information accessible to everyone via the Legris website

www.legris.com includes the complete range of European, Asian and American products and gives **access** to thousands of product part numbers. Three search facilities direct the user to a complete and **real-time, updated** product file with technical drawings and pictures.

Each catalogue offers the possibility to place and receive **quotation requests**, which will be sent to distributors within the same corresponding geographical area.

Sections containing technical advice and animated graphics offer the user an **optimized understanding** of product technologies and their applications.



Saving on design time with downloadable CAD drawings

Legris Connectic offers the possibility to download CAD drawings for a large number of products. This service is available to all, via legris.com, through a **free, easy and quick** download and the formats provided (2D and 3D) are compatible with the main CAD systems used worldwide.

This enables time saving in equipment design: each downloaded component can be directly integrated into an assembly, with the associated nomenclature. In addition, this service **guarantees** choice. Indeed, with Legris CAD drawings you can ensure that the selected components are suitable for use with other components within the assembly.



build your installation with the Legris range

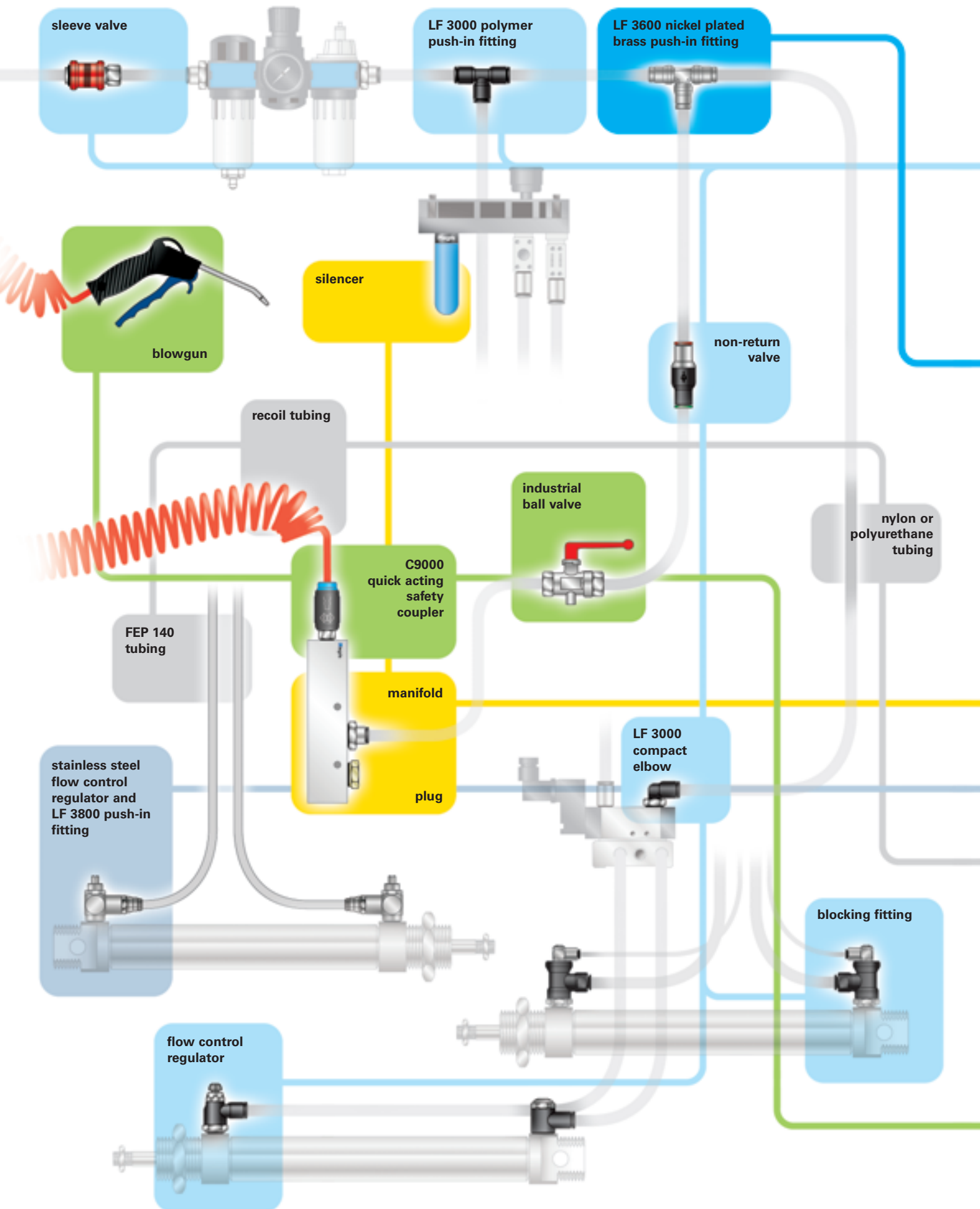

contents of this product guide

Pneumatic applications

LF 3000 polymer push-in fittings, flow control regulators and pneumatic function fittings
pages 6 to 15



For all fluid applications

LF 3600 chemical nickel-plated brass push-in fittings
pages 16 to 17



For aggressive fluids and environments

Stainless steel fittings : LF 3800 push-in fittings, flow control regulators and accessories
pages 20 to 22



Accessories and plugs

pages 18 to 19



Technical tubes

pages 23 to 25



Complementary range

Complementary range : quick acting couplers, blowguns and ball valves
pages 26 to 28



LF 3000 polymer push-in fittings

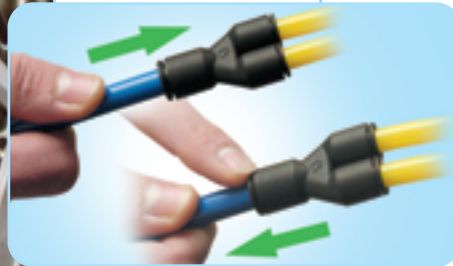
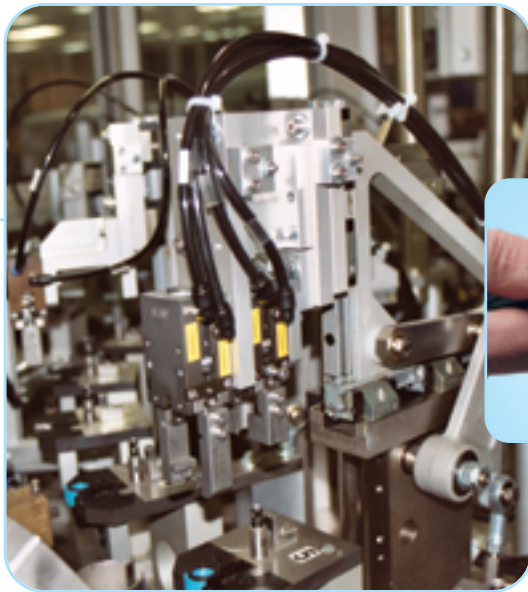

Applications

- used to connect **pneumatic** devices in **many industrial applications** : assembly machines, packaging equipment, factory automation, automotive process industry, textile machinery, printing machinery, vacuum networks ...etc
The LF 3000 range meets the latest international **standard ISO 14743**, for push-in connectors used in conjunction with thermoplastic tubes.

Benefits

- **time saving** and **simplicity** of installation : instant connection and disconnection without the use of tools

- **full flow** as gripping and sealing are achieved using the outside of the tube.
- **immediate sealing** : reinforced sealing by a captive 'O' ring seal for parallel threaded fittings and pre-coating for taper threaded fittings.
- **compactness and aesthetic** : optimised dimensions and internal hexagons on straight fittings.
- **orientable** body for positioning purposes



■ a solution for all applications

- wide variety of body designs and numerous configurations from 3 to 14 mm diameters.
- 3 types of thread : BSP parallel and metric parallel, BSP taper.

Special versions available on request – Please consult us.

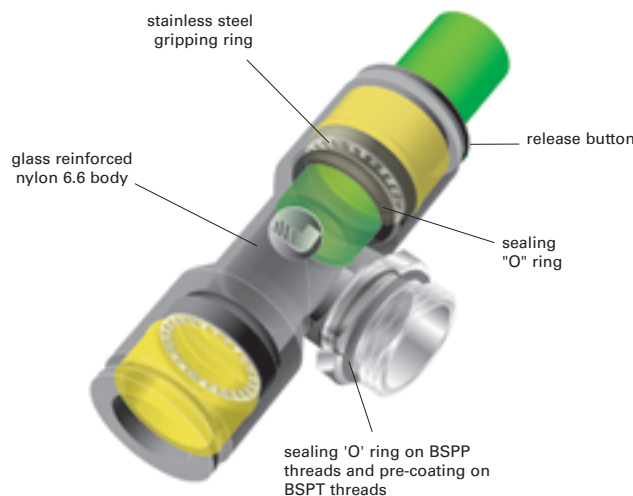

Technical specifications

suitable fluids :
compressed air

LF 3000® can also be used for conveying various types of liquids (water, cutting oil, etc) for industrial applications. The working pressure, from 0 to 6/10 bar, and temperatures, from 0 to 60°C, are dependent upon the fluid conveyed and the type of 'O' ring used. For further information, please consult us.

working pressure :
20 bar maximum

vacuum capability :
vacuum of 755 mm Hg (99% vacuum)

working temperature :
- 20° to + 80°C

All items in the LF 3000 range are guaranteed **silicone free**.

maximum tightening torque for LF 3000® fittings, BSPP and metric threads

Thread	M3 x 0,5	M5 x0,8	M7 x1	G1/8"	G1/4"	G3/8"	G1/2"
da N.m	0,06	0,16	0,8	0,8	1,2	3	3,5

threaded fittings

Designed to satisfy your requirements

3109



- compactness for better space utilisation
- the body is **orientable** for positioning purposes
- allowing overlap assembly with extended elbow (model 3129)
- available from 4 mm to 14 mm diameters

male stud fitting, hexagonal, BSPT thread

3175



ØD	C	
4	R1/8	3175 04 10
4	R1/4	3175 04 13
6	R1/8	3175 06 10
6	R1/4	3175 06 13
6	R3/8	3175 06 17
6	R1/2	3175 06 21
8	R1/8	3175 08 10
8	R1/4	3175 08 13
8	R3/8	3175 08 17
10	R1/4	3175 10 13
10	R3/8	3175 10 17
10	R1/2	3175 10 21
12	R3/8	3175 12 17
12	R1/2	3175 12 21
14	R3/8	3175 14 17
14	R1/2	3175 14 21

male stud fitting, hexagonal, BSPP and metric thread

3101



ØD	C	
4	M5x0,8	3101 04 19
4	G1/8	3101 04 10
4	G1/4	3101 04 13
6	M5x0,8	3101 06 19
6	G1/8	3101 06 10
6	G1/4	3101 06 13
6	G3/8	3101 06 17
8	G1/8	3101 08 10
8	G1/4	3101 08 13
8	G3/8	3101 08 17
10	G1/4	3101 10 13
10	G3/8	3101 10 17
10	G1/2	3101 10 21
12	G3/8	3101 12 17
12	G1/2	3101 12 21
14	G3/8	3101 14 17
14	G1/2	3101 14 21

male stud elbow, BSPT thread

3109



ØD	C	
4	R1/8	3109 04 10
4	R1/4	3109 04 13
4	R3/8	3109 04 17
6	R1/8	3109 06 10
6	R1/4	3109 06 13
6	R3/8	3109 06 17
8	R1/8	3109 08 10
8	R1/4	3109 08 13
8	R3/8	3109 08 17
10	R1/4	3109 10 13
10	R3/8	3109 10 17
10	R1/2	3109 10 21
12	R3/8	3109 12 17
12	R1/2	3109 12 21
14	R3/8	3109 14 17
14	R1/2	3109 14 21

extended male stud elbow, BSPT thread

3129



ØD	C	
4	R1/8	3129 04 10
4	R1/4	3129 04 13
6	R1/8	3129 06 10
6	R1/4	3129 06 13
8	R1/8	3129 08 10
8	R1/4	3129 08 13
8	R3/8	3129 08 17
10	R1/4	3129 10 13
10	R3/8	3129 10 17
10	R1/2	3129 10 21

male stud elbow, BSPP and metric thread

3199



ØD	C	
4	M5x0,8	3199 04 19
4	G1/8	3199 04 10
4	G1/4	3199 04 13
6	M5x0,8	3199 06 19
6	G1/8	3199 06 10
6	G1/4	3199 06 13
6	G3/8	3199 06 17
8	G1/8	3199 08 10
8	G1/4	3199 08 13
8	G3/8	3199 08 17
10	G1/4	3199 10 13
10	G3/8	3199 10 17
10	G1/2	3199 10 21
12	G3/8	3199 12 17
12	G1/2	3199 12 21
14	G3/8	3199 14 17
14	G1/2	3199 14 21

extended male stud elbow, BSPP and metric thread

3169



ØD	C	
4	M5x0,8	3169 04 19
4	G1/8	3169 04 10
6	M5x0,8	3169 06 19
6	G1/8	3169 06 10
6	G1/4	3169 06 13
8	G1/8	3169 08 10
8	G1/4	3169 08 13

45° male elbow, BSPT thread

3113



ØD	C	
4	R1/8	3113 04 10
6	R1/8	3113 06 10
6	R1/4	3113 06 13
8	R1/8	3113 08 10
8	R1/4	3113 08 13
8	R3/8	3113 08 17

45° male elbow, BSPP and M5 thread

3133



ØD	C	
4	M5x0,8	3133 04 19
4	G1/8	3133 04 10
6	M5x0,8	3133 06 19
6	G1/8	3133 06 10
6	G1/4	3133 06 13
8	G1/8	3133 08 10
8	G1/4	3133 08 13
8	G3/8	3133 08 17

female stud fitting, BSPP and M5 thread

3114



ØD	C	
4	M5x0,8	3114 04 19
4	G1/8	3114 04 10
4	G1/4	3114 04 13
6	G1/8	3114 06 10
6	G1/4	3114 06 13
8	G1/8	3114 08 10
8	G1/4	3114 08 13

female stud elbow, BSPP thread

3192



ØD	C	
4	G1/8	3192 04 10
4	G1/4	3192 04 13
6	G1/8	3192 06 10
6	G1/4	3192 06 13
8	G1/8	3192 08 10
8	G1/4	3192 08 13

Multiple configurations

Legris offers a solution for all tubing configurations.

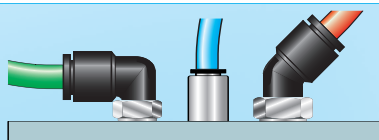

threaded fittings

male stud branch tee,
BSPP and M5 thread

3198 ØD C

4 M5x0,8	3198 04 19
4 G1/8	3198 04 10
6 M5x0,8	3198 06 19
6 G1/8	3198 06 10
6 G1/4	3198 06 13
8 G1/8	3198 08 10
8 G1/4	3198 08 13

male stud run tee,
BSPP and M5 thread

3193 ØD C

4 M5x0,8	3193 04 19
4 G1/8	3193 04 10
6 G1/8	3193 06 10
6 G1/4	3193 06 13
8 G1/8	3193 08 10
8 G1/4	3193 08 13

'Y' piece male,
BSPP and M5 thread

3158 ØD C

4 M5x0,8	3158 04 19
4 G1/8	3158 04 10
4 G1/4	3158 04 13
6 G1/8	3158 06 10
6 G1/4	3158 06 13
8 G1/8	3158 08 10
8 G1/4	3158 08 13

double banjo,
BSPP and M5 thread

3119 ØD C

4 M5x0,8	3119 04 19
4 G1/8	3119 04 10
6 G1/8	3119 06 10
6 G1/4	3119 06 13
8 G1/4	3119 08 13
8 G3/8	3119 08 17

twin banjo,
BSPP and metric thread

3149 ØD C

4 M5x0,8	3149 04 19
4 G1/8	3149 04 10
4 G1/4	3149 04 13
6 G1/8	3149 06 10
6 G1/4	3149 06 13
6 G3/8	3149 06 17
8 G1/4	3149 08 13
8 G3/8	3149 08 17

single banjo,
BSPP and M5 thread

3118 ØD C

4 M5x0,8	3118 04 19
4 G1/8	3118 04 10
6 M5x0,8	3118 06 19
6 G1/8	3118 06 10
6 G1/4	3118 06 13
8 G1/8	3118 08 10
8 G1/4	3118 08 13
8 G3/8	3118 08 17

single banjo with female BSPP
bolt, M5 and BSPP thread

3124 ØD C

4 M5x0,8	3124 04 19
4 G1/8	3124 04 10
6 G1/4	3124 06 13
8 G3/8	3124 08 17

Legris banjos allow easy access, even when connections are close together.

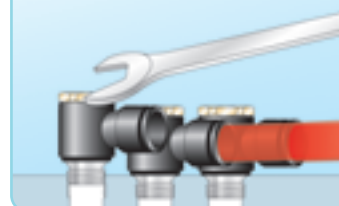

tube-to-tube fittings

tube/tube connector

3106 ØD

4	3106 04 00
6	3106 06 00
8	3106 08 00
10	3106 10 00
12	3106 12 00
14	3106 14 00

equal elbow

3102 ØD

4	3102 04 00
6	3102 06 00
8	3102 08 00
10	3102 10 00
12	3102 12 00
14	3102 14 00

equal and unequal tee

3104 ØD1 ØD2

4	3104 04 00
6	3104 06 00
6 4	3104 06 04
8	3104 08 00
8 6	3104 08 06
10	3104 10 00
10 8	3104 10 08
12	3104 12 00
14	3104 14 00

single 'Y' piece –
equal and unequal

3140 ØD1 ØD2

4 4	3140 04 00
4 6	3140 04 06
6 6	3140 06 00
6 8	3140 06 08
8 8	3140 08 00

multiple "Y" piece -
equal and unequal

3144 ØD1 ØD2

4 4	3144 04 04
4 6	3144 04 06
6 6	3144 06 06
6 8	3144 06 08

multiple tee
with fixing holes

3304 ØD1 ØD2

6 4	3304 06 04
8 4	3304 08 04
8 6	3304 08 06
10 6	3304 10 06
10 8	3304 10 08

unequal multiple elbow
with fixing holes

3306 ØD1 ØD2

6 4	3306 06 04
8 4	3306 08 04
8 6	3306 08 06
10 6	3306 10 06
10 8	3306 10 08

equal cross,
with fixing holes

3107 ØD

4	3107 04 00
6	3107 06 00
8	3107 08 00

the "plus" of legris.com



Download **CAD drawings** of all **LF 3000®** models from the online catalogue of legris.com. Formats (2D and 3D) are compatible with principal worldwide CAD platforms. A **free service** accessible to everyone.

www.legris.com



tube-to-tube bulkhead fittings

bulkhead connector

3116 

ØD	C	
4	16	3116 04 00
6	18	3116 06 00
8	21,5	3116 08 00
10	26	3116 10 00
12	31	3116 12 00
14	34,5	3116 14 00



female bulkhead connector, BSPP thread

3136 

ØD	C	
4	G1/8	3136 04 10
4	G1/4	3136 04 13
6	G1/8	3136 06 10
6	G1/4	3136 06 13
8	G1/8	3136 08 10
8	G1/4	3136 08 13



equal bulkhead elbow

3139 

ØD	C	
4	16	3139 04 00
6	18	3139 06 00
8	21,5	3139 08 00

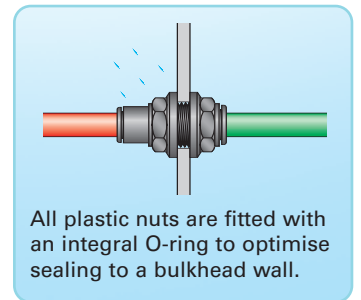
plug-in fittings and accessories

male standpipe, BSPT thread

3121 

ØD	C	
4	R1/8	3121 04 10
4	R1/4	3121 04 13
6	R1/8	3121 06 10
6	R1/4	3121 06 13
8	R1/8	3121 08 10
8	R1/4	3121 08 13
8	R3/8	3121 08 17
10	R1/4	3121 10 13
10	R3/8	3121 10 17
10	R1/2	3121 10 21
12	R3/8	3121 12 17
12	R1/2	3121 12 21
14	R1/2	3121 14 21



male standpipe, BSPP and M5 thread

3131 

ØD	C	
4	M5x0,8	3131 04 19
4	G1/8	3131 04 10
4	G1/4	3131 04 13
6	G1/8	3131 06 10
6	G1/4	3131 06 13
8	G1/8	3131 08 10
8	G1/4	3131 08 13
8	G3/8	3131 08 17



plug-in equal compact elbow with plastic tailpiece

3182 

ØD	C	
4	4	3182 04 00
6	6	3182 06 00
8	8	3182 08 00



plug-in equal compact tee with plastic tailpiece

3188 

ØD	C	
4	4	3188 04 00
6	6	3188 06 00
8	8	3188 08 00



reducer

3166 

ØD	C	
4	6	3166 04 06
4	8	3166 04 08
6	8	3166 06 08
6	10	3166 06 10
8	10	3166 08 10
8	12	3166 08 12
8	14	3166 08 14
10	12	3166 10 12
10	14	3166 10 14
12	14	3166 12 14



increaser

3168 

ØD	C	
6	4	3168 06 04
8	6	3168 08 06
10	8	3168 10 08



double male stem connector

3120 

ØD	
6	3120 06 00
8	3120 08 00
10	3120 10 00



blanking plug

3126 

ØD	
4	3126 04 00
6	3126 06 00
8	3126 08 00



multi connectors and manifolds

male screw body

3320 

o.d. tube	number of outlets	
4	4	3320 04 00 04
4	7	3320 04 00 07
4	12	3320 04 00 12
6	4	3320 06 00 04
6	7	3320 06 00 07



female screw body

3321 

o.d. tube	number of outlets	
4	4	3321 04 00 04
4	7	3321 04 00 07
4	12	3321 04 00 12
6	4	3321 06 00 04
6	7	3321 06 00 07



screw cap

3329 

number of outlets	
4-7	3329 00 02
12	3329 00 03



manifold with LF 3000 push-in connection

3310 

ØD	C	
4	G1/4	3310 04 13
6	G1/4	3310 06 13
8	G3/8	3310 08 17



Carstick® cartridges

Carstick®

3100

ØD cartridge	
4	3100 04 00
6	3100 06 00
8	3100 08 00
10	3100 10 00
10	3100 12 00



Ideal for **continuous processes**, Carstick cartridge provides a **high performance** solution for automatic, semi-automatic and manual assembly equipment for pneumatic components. Please consult us for detailed drawings of cavity dimensions and tolerances. Special versions available on request. Please consult us.

Carstick® assembly

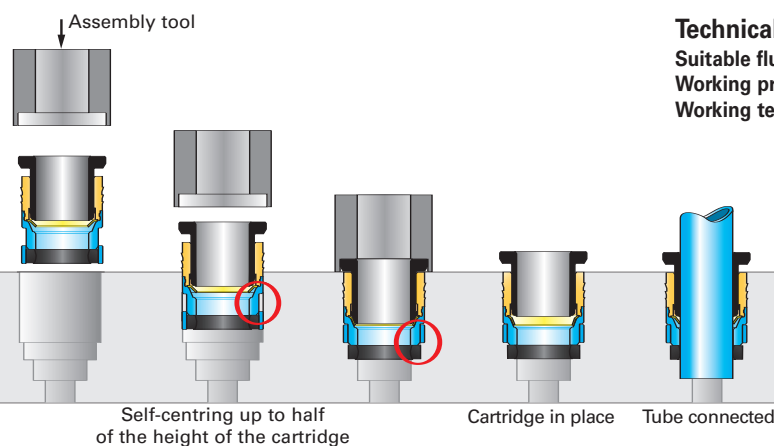

Technical specifications

Suitable fluid : compressed air
Working pressure : maximum 20 bar
Working temperature : - 20° to + 80°C

Self-centring up to half of the height of the cartridge Cartridge in place Tube connected

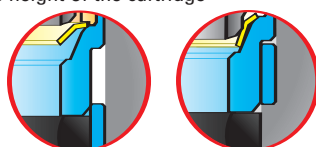

Depression of seal protection leaves seal locked into cavity

accessories

reducer male to female,
BSPP and metric thread

0178

C1	C2	
M7x1	M5x0,8	0178 55 19
G1/8	M5x0,8	0178 10 19
G1/4	G1/8	0178 13 10
G3/8	G1/8	0178 17 10
G3/8	G1/4	0178 17 13
G1/2	G1/4	0178 21 13
G1/2	G3/8	0178 21 17
G3/4	G1/2	0178 27 21



increaser male to female,
BSPP and metric thread

0179

C1	C2	
M12x1,5	G1/4	0179 67 13
G1/8	G1/4	0179 10 13
G1/4	G3/8	0179 13 17
G3/8	G1/2	0179 17 21



threaded plug,
BSPP and metric thread

0222

C	
M5x08	0222 19 00
M7x1	0222 55 00
G1/8	0222 10 00
G1/4	0222 13 00
G3/8	0222 17 00
G1/2	0222 21 00



clip strips for tubes

clip

ØD	
4	Clip 04 00
6	Clip 06 00
8	Clip 08 00
10	Clip 10 00
12	Clip 12 00
14	Clip 14 00



The LF 3000® system is designed for use with **various types of tubing** found in this product guide :

■ **semi-rigid nylon tube** :
3 mm OD to 14mm OD

■ **flexible polyurethane tube** :
3 mm OD to 14mm OD

■ **fluoropolymer tube** :
4 mm OD to 12mm OD



Flow control regulators

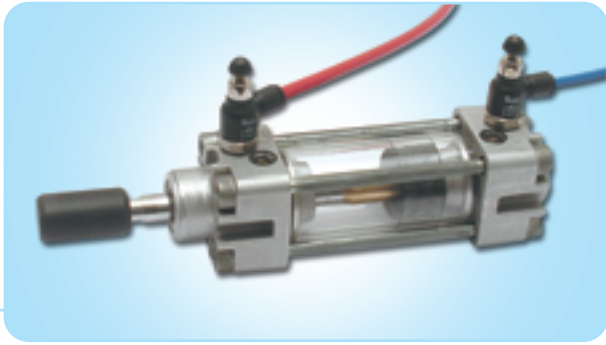

Applications

- In the field of industrial automation the fittings control the speed of a pneumatic cylinder. The exhaust air flow is controlled by an adjustable restrictor. The inlet flow is unrestricted full bore. Depending upon the model, Legris flow control regulators may be fitted : to the cylinder (exhaust version), to the control valve (supply version) or in the compressed air line (in-line version).

Benefits

- perfectly controlled sealing both externally (tube outlet and sub-base) and internally (adjustment screw)
- stability, progressiveness and accuracy of flow
- LF 3000 instant connection ensures quick assembly
- designed for easy adjustment

Choosing a flow control regulator

conditions of use

▶ standard conditions
 ▼
 models in polymer

▶ severe conditions
 ▼
 models in metal

dimensions

▶ standard conditions with full flow performance
 ▼
 compact models

▶ for very small cylinders with accurate adjustment
 ▼
 miniature models

type of adjustment

▶ manual adjustment
 ▼
 models with external screw

▶ adjustment with screwdriver
 ▼
 models with recessed screw

configurations of the installation

▶ standard applications
 ▼
 banjo types

▶ vertical or angled exit
 ▼
 swivel outlet types

▶ difficult access of cylinder
 ▼
 in-line types

To assist differentiation, each version is identified by the corresponding **pneumatic symbol** and a **letter** :

- one-way adjustment
 "exhaust" version :
 letter **A**

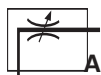

- "supply" version :
 letter **B**

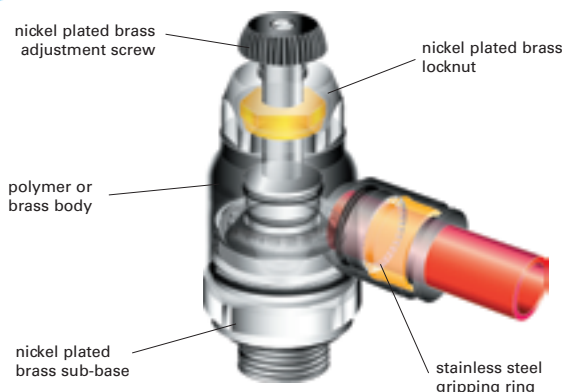

Technical specifications

suitable fluid :
 compressed air

working pressure :
 1 to 10 bar

working temperature :
 0° to + 70°C

flow control regulators

polymer version

Designed to satisfy your requirements

7010



- the recessed adjustment screw reduces external dimensions thus allowing use in **reduced spaces** and **on small cylinders**
- the recessed screw provides **security** and helps to **prevent** unwanted adjustment.
- also available in metal version (7130)

with recessed adjustment screw, BSPP and M5 thread



7010

ØD	C	
4	M5x0,8	7010 04 19
4	G1/8	7010 04 10
6	M5x0,8	7010 06 19
6	G1/8	7010 06 10
6	G1/4	7010 06 13
8	G1/8	7010 08 10
8	G1/4	7010 08 13
8	G3/8	7010 08 17
10	G1/4	7010 10 13
10	G3/8	7010 10 17
10	G1/2	7010 10 21
12	G3/8	7010 12 17
12	G1/2	7010 12 21



"miniature", BSPP and metric thread



7660

ØD	C	
4	M5x0,8	7660 04 19
4	G1/8	7660 04 10
6	M5x0,8	7660 06 19
6	G1/8	7660 06 10
6	G1/4	7660 06 13
8	G1/8	7660 08 10
8	G1/4	7660 08 13



"miniature", BSPP and metric thread



7669

ØD	C	
4	M5x0,8	7669 04 19
4	G1/8	7669 04 10
6	M5x0,8	7669 06 19
6	G1/8	7669 06 10
6	G1/4	7669 06 13
8	G1/8	7669 08 10
8	G1/4	7669 08 13



"compact", BSPP thread



7060

ØD	C	
4	G1/8	7060 04 10
6	G1/8	7060 06 10
6	G1/4	7060 06 13
8	G1/8	7060 08 10
8	G1/4	7060 08 13
8	G3/8	7060 08 17
10	G1/4	7060 10 13
10	G3/8	7060 10 17
12	G3/8	7060 12 17
12	G1/2	7060 12 21



"compact", swivel outlet type, BSPP thread



7040

ØD	C	
6	G1/8	7040 06 10
6	G1/4	7040 06 13
8	G1/8	7040 08 10
8	G1/4	7040 08 13
8	G3/8	7040 08 17
10	G1/4	7040 10 13
10	G3/8	7040 10 17
12	G3/8	7040 12 17
12	G1/2	7040 12 21



"in-line" with LF3000 push-in connection



7770

ØD	
4	7770 04 00
6	7770 06 00
8	7770 08 00
10	7770 10 00
12	7770 12 00



"in-line" with push-in connections, panel mountable



7776

ØD	
4	7776 04 00
6	7776 06 00
8	7776 08 00
10	7776 10 00
12	7776 12 00



metal version

"compact" with push-in connection, BSPP thread



7100

ØD	C	
4	G1/8	7100 04 10
6	G1/8	7100 06 10
6	G1/4	7100 06 13
8	G1/8	7100 08 10
8	G1/4	7100 08 13
8	G3/8	7100 08 17
10	G1/4	7100 10 13
10	G3/8	7100 10 17
12	G3/8	7100 12 17
12	G1/2	7100 12 21
14	G1/2	7100 14 21



"compact" with threaded fitting, BSPP thread



7110

C	
G1/8	7110 10 10
G1/4	7110 13 13
G3/8	7110 17 17
G1/2	7110 21 21



with push-in connection, BSPP - recessed adjustment screw



7130

ØD	C	
4	M5x0,8	7130 04 19
4	G1/8	7130 04 10
6	M5x0,8	7130 06 19
6	G1/8	7130 06 10
6	G1/4	7130 06 13
8	G1/8	7130 08 10
8	G1/4	7130 08 13
8	G3/8	7130 08 17



with brass compression fitting and external adjustment screw, BSPP thread



7762

ØD	C	
8	G1/8	7762 08 10*
10	G1/4	7762 10 13
14	G3/8	7762 14 17
18	G1/2	7762 18 21



* with adjustment knurl

flow control regulators

flow characteristics (at 6 bar)

6 bar
— return
— adjustment
 F : flow in NI/min N : number of turns

7010

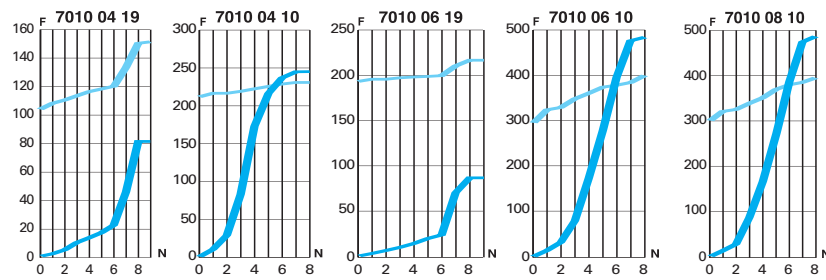

7660

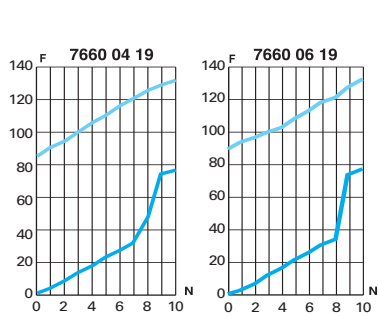
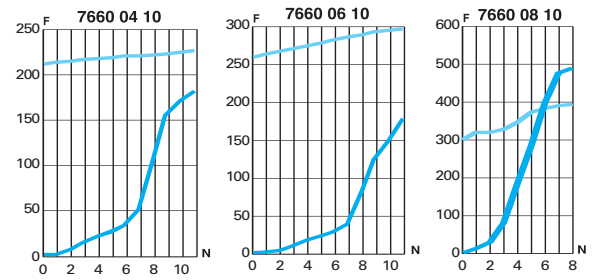

7669

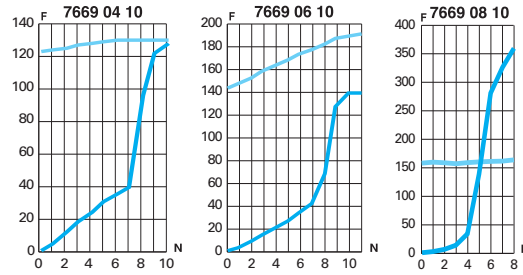

7060

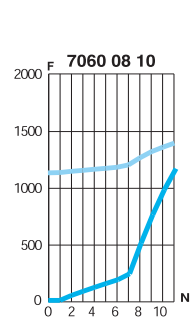
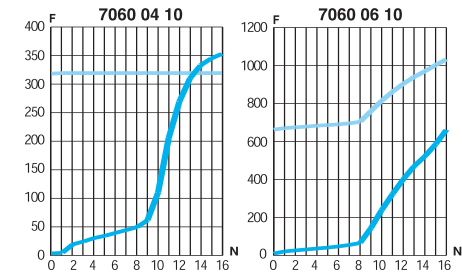

7770

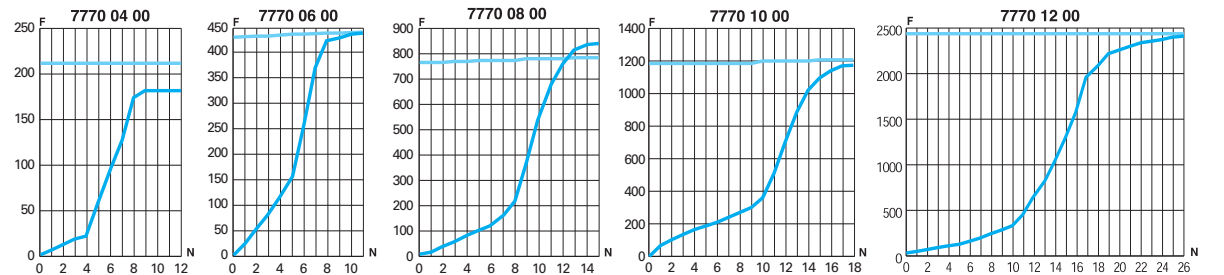

7776

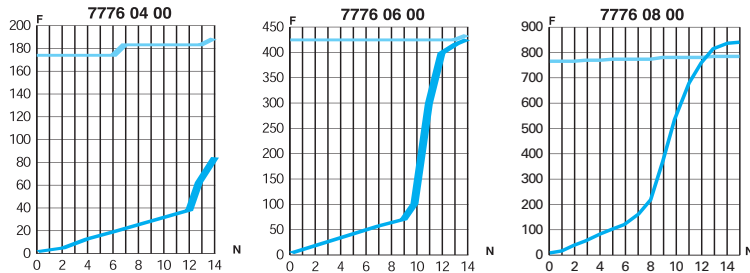

7100

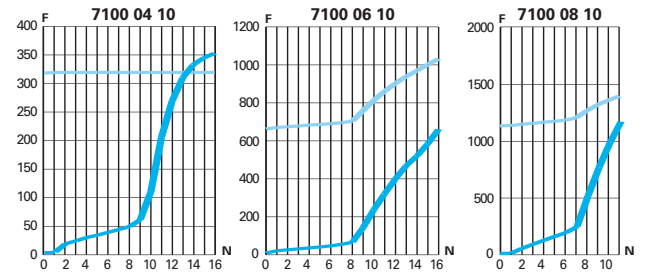

7110

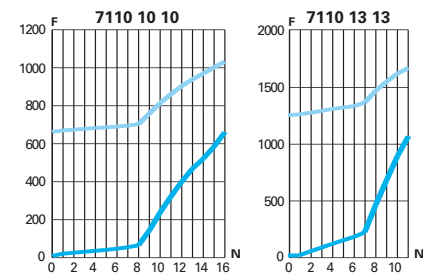

7130

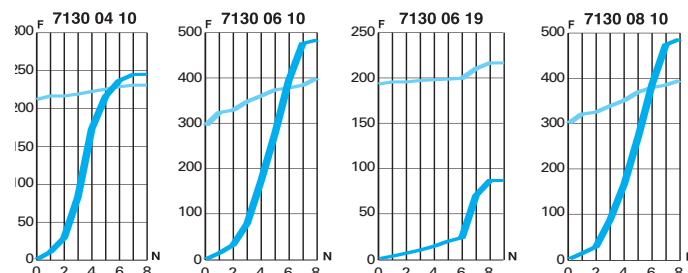

the "plus" of legris.com



Select and download **CAD drawings** of flow control regulators easily and quickly. An optimised and **free service**, available to everyone on the Legris web-site.

www.legris.com



Pneumatic function fittings

Applications

Legris pneumatic function fittings are designed to provide **added value connection** solutions.

They have an **important part** to play within many installations

Here are few examples :

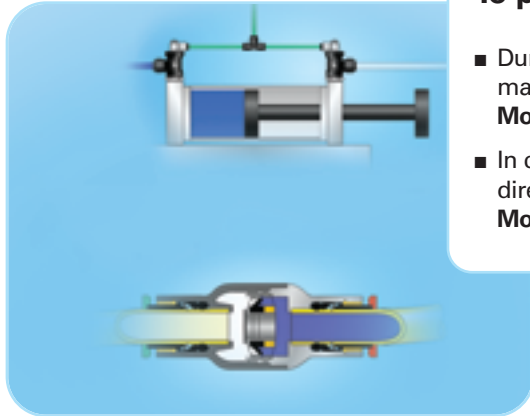

To protect your installation

- During an emergency stop of a pneumatic installation, blocking fittings are designed to maintain loads.
Model 7881
- In case of failure of the power supply, non-return valves allow air to pass in one direction whilst blocking flow in the other.
Models : in polymer 7996 - in stainless steel 4890

To adjust performance of your installation

- In order to adjust pressure to the required value, pressure regulator fittings stabilize at a given value the pressure applied to pneumatic equipment, whatever the fluctuations of pressure upstream.
Model 7300
- **Pressure reducer fittings** enable manual adjustment of the circuit pressure applied to pneumatic equipment, limiting the cylinder pressure.
Models 7316

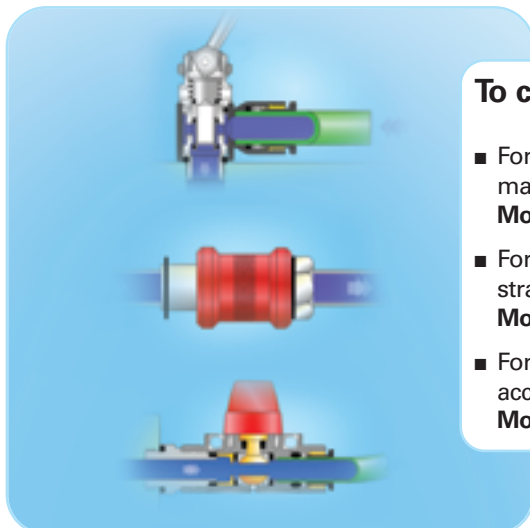

To control your installation

- For immediate and direct opening/closure of specific area of your installation supply, manually operated valves require just a simple manual operation.
Models 7800 – 7801
- For immediate venting of a pneumatic circuit, pneumatic sleeve valves need only a straightforward lateral movement of the sleeve.
Model 0669
- For closure/purge of a pneumatic circuit, mini-ball valves are very easy to use where access is difficult and space is at a premium.
Models 7913 – 7910

Legris.com's plus points



You will find in the legris.com learning space, numerous **animated presentations** of these fittings : their technology and their functions.

www.legris.com



pneumatic function fittings

blocking fittings

male thread BSPP, with threaded fitting



7881

C1	C2	
G1/8	G1/4	7881 13 10
G1/4	G1/4	7881 13 13
G3/8	G3/8	7881 17 17
G1/2	G1/2	7881 21 21

ØC2
ØC1

working pressure : 1 to 10 bar
working temperature : -20° to + 70°C
materials :
- body : treated brass

male thread BSPP, with LF 3000 push-in connection



7880

ØD	C	
6	G1/8	7880 06 10
6	G1/4	7880 06 13
8	G1/4	7880 08 13
8	G3/8	7880 08 17
10	G3/8	7880 10 17
12	G1/2	7880 12 21

working pressure : 1 to 10 bar
working temperature : -20° to + 70°C
materials :
- body : treated brass

non-return valves

in-line non-return valve with LF 3000 push-in connection



7996

ØD	
4	7996 04 00
6	7996 06 00
8	7996 08 00
10	7996 10 00
12	7996 12 00

working pressure : 1 to 10 bar
working temperature : 0° to + 70°C
materials :
- body : polymer and nickel plated brass

You will also find, on page 21, non-return valves in stainless steel.

manual operated vent fittings

pneumatic sleeve valve, double female, BSPP thread

0669

C	DN	
M5x0,8	2	0669 02 19
G1/8	4	0669 04 10
G1/4	7	0669 07 13
G3/8	10	0669 10 17
G1/2	14	0669 14 21
G3/4	19	0669 19 27

working pressure : 16 bar
working temperature : -10° to + 80°C
materials :
- body : nickel plated brass
- sleeve : anodised aluminium

3/2 manual switch operated valve, with push-in connection, BSPP thread



7800

ØD	C	
4	G1/8	7800 04 10
4	M5x0,8	7800 04 19
6	G1/8	7800 06 10
6	G1/4	7800 06 13
6	M5x0,8	7800 06 19
8	G1/8	7800 08 10
8	G1/4	7800 08 13
10	G1/4	7800 10 13

working pressure : 10 bar
working temperature : -10° to + 80°C
materials :
- body : polymer and nickel plated brass

mini ball valves

3/2, with vent, with push-in connection



7913

ØD	
4	7913 04 00
6	7913 06 00
8	7913 08 00
10	7913 10 00
12	7913 12 00

working pressure : 1 to 10 bar
working temperature : -20° to + 80°C
materials :
- body : polymer

2/2, with push-in connection



7910

ØD	
4	7910 04 00
6	7910 06 00
8	7910 08 00
10	7910 10 00
12	7910 12 00

working pressure : 1 to 10 bar
working temperature : -20° to + 80°C
materials :
- body : polymer

pressure regulator fittings

male BSPP, with push-in fitting connection and engineering plastic body



7300

ØD	C	
4	G1/8	7300 04 10
6	G1/8	7300 06 10
6	G1/4	7300 06 13
8	G1/8	7300 08 10
8	G1/4	7300 08 13
8	G3/8	7300 08 17

working pressure :
- input pressure : 1 to 16 bar
- regulated pressure : 1 to 8 bar
working temperature : -10° to + 70°C
materials :
- body : polymer and nickel plated brass

pressure reducer fittings

in-line, with LF 3000 push-in fittings



7316

ØD	
6	7316 06 00
8	7316 08 00
10	7316 10 00

Suitable fluid : compressed air
Working pressure : 1 to 8 bar
Working temperature :
- 15° to + 60°C

pneumatic sensor fittings

male thread BSPP and metric, with LF 3000 push-in connection



7818

C	
M5x0,8	7818 04 19
G1/8	7818 04 10
G1/4	7818 04 13
G3/8	7818 04 17
G1/2	7818 04 21

Working pressure : 3 to 8 bar
Working temperature :
- 15° to + 60°C
Breaking pressure : 0,6 bar
Response time : 3 ms

LF 3600

chemical nickel-plated brass push-in fittings

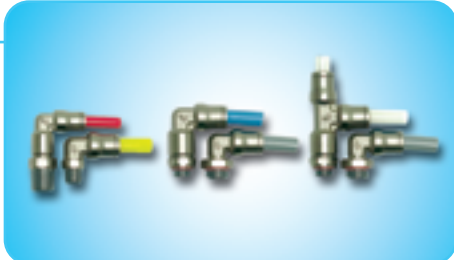
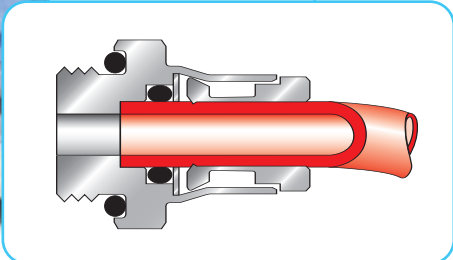

Applications

- LF 3600 is compatible with **many liquids and gases** and is ideal for environments that require mechanical strength.
- suited to many specialist applications : **industrial, chemical, pharmaceutical** and **food** applications.
- components and chemical nickel coating are authorized by **FDA standard** (Food & Drug Administration). LF 3600 range is recommended in food process applications.

Benefits

- **excellent resistance to abrasion and corrosion** due to high phosphorus chemical nickel plating of individual brass components.

- **time saving and simplicity** of installation : instant **manual** connection and disconnection, easy installation.
- **full flow** fluid passage, minimal pressure drop.
- **automatic sealing** of parallel threaded versions via an integral sub-base FKM seal.
- **compactness due to small overall** dimensions with inter-connectability for bespoke configurations.
- aesthetic with **modernised** external shapes



ability to suit your requirements

Legris has developed semi-standard LF 3600 models for **specific applications** such as coffee machines.

Do not hesitate to contact us for further information.

Technical specifications

- suitable fluids :** all liquids and gases compatible with the materials of the fitting.
Examples : compressed air, cleaning/cold and hot water, steam, oils ...
- working pressure :** maximum 20 bar
- working temperature :** - 20° to + 120°C
- vacuum capability :** vacuum of 750 mm Hg (90% vacuum)

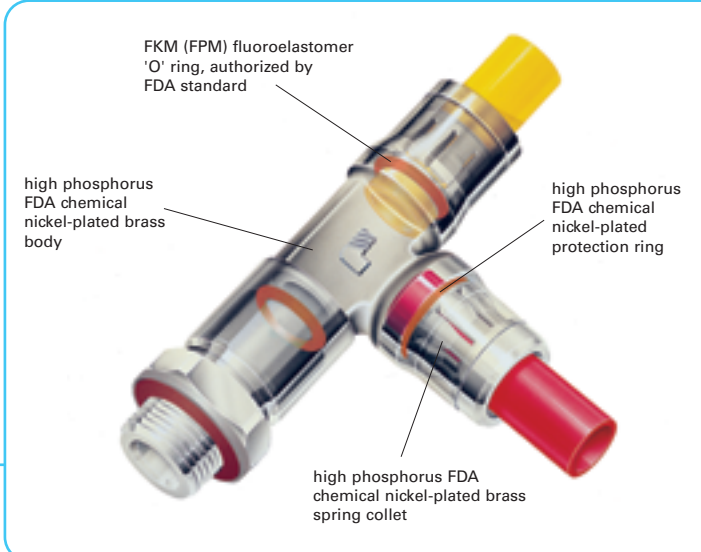

All items in the LF 3600 range are guaranteed **silicone free**.

maximum tightening torque for LF 3600® fittings, BSPP and metric threads	Thread	M5 x0,8	G1/8"	G1/4"	G3/8"	G1/2"
	da N.m	0,16	0,8	1,2	3	3,5

LF3600 chemical nickel plated brass push-in fittings

Designed to satisfy your requirements

3601



- automatic sealing of parallel thread via an integral sub-base FKM seal
- internal hexagon for installation in tight places
- high phosphorus chemical nickel plating of individual brass components for an excellent resistance to abrasion and corrosion
- "all metal" components (except seals) that allow working temperature from -20° to +120°C

male stud, BSP parallel and metric thread

3601

ØD	C	
4	M5x0,8	3601 04 19
4	G1/8	3601 04 10
4	G1/4	3601 04 13
6	M5x0,8	3601 06 19
6	G1/8	3601 06 10
6	G1/4	3601 06 13
8	G1/8	3601 08 10
8	G1/4	3601 08 13
8	G3/8	3601 08 17
10	G1/4	3601 10 13
10	G3/8	3601 10 17
10	G1/2	3601 10 21
12	G1/4	3601 12 13
12	G3/8	3601 12 17
12	G1/2	3601 12 21
14	G3/8	3601 14 17
14	G1/2	3601 14 21



female stud, metric thread

3614

ØD	C	
4	G1/8	3614 04 10
4	G1/4	3614 04 13
6	G1/8	3614 06 10
6	G1/4	3614 06 13
8	G1/8	3614 08 10
8	G1/4	3614 08 13



male stud elbow, BSPP and metric thread

3699

ØD	C	
4	M5x0,8	3699 04 19
4	G1/8	3699 04 10
4	G1/4	3699 04 13
6	G1/8	3699 06 10
6	G1/4	3699 06 13
8	G1/8	3699 08 10
8	G1/4	3699 08 13
8	G3/8	3699 08 17
10	G1/4	3699 10 13
10	G3/8	3699 10 17
12	G1/4	3699 12 13
12	G3/8	3699 12 17
12	G1/2	3699 12 21
14	G3/8	3699 14 17
14	G1/2	3699 14 21



extended male stud elbow, BSPP and metric thread

3669

ØD	C	
4	M5x0,8	3669 04 19
4	G1/8	3669 04 10
6	G1/8	3669 06 10
6	G1/4	3669 06 13
8	G1/8	3669 08 10
8	G1/4	3669 08 13



male stud branch tee, BSPP and metric thread

3698

ØD	C	
4	M5x0,8	3698 04 19
4	G1/8	3698 04 10
6	G1/8	3698 06 10
6	G1/4	3698 06 13
8	G1/8	3698 08 10
8	G1/4	3698 08 13



male stud run tee, BSPP and metric thread

3693

ØD	C	
4	M5x0,8	3693 04 19
4	G1/8	3693 04 10
6	G1/8	3693 06 10
6	G1/4	3693 06 13
8	G1/8	3693 08 10
8	G1/4	3693 08 13



equal tee

3604

ØD	
4	3604 04 00
6	3604 06 00
8	3604 08 00
10	3604 10 00
12	3604 12 00
14	3604 14 00



equal tube to tube connector

3606

ØD	
4	3606 04 00
6	3606 06 00
8	3606 08 00
10	3606 10 00
12	3606 12 00
14	3606 14 00



equal elbow

3602

ØD	
4	3602 04 00
6	3602 06 00
8	3602 08 00
10	3602 10 00
12	3602 12 00
14	3602 14 00



single banjo, BSPP and metric thread

3618

ØD	C	
4	M5x0,8	3618 04 19
4	G1/8	3618 04 10
6	M5x0,8	3618 06 19
6	G1/8	3618 06 10
6	G1/4	3618 06 13
8	G1/8	3618 08 10
8	G1/4	3618 08 13



equal bulkhead connector

3616

ØD	
4	3616 04 00
6	3616 06 00
8	3616 08 00
10	3616 10 00
12	3616 12 00
14	3616 14 00



plug-in reducer

3666

ØD1	ØD2	
4	6	3666 04 06
4	8	3666 04 08
6	8	3666 06 08
6	10	3666 06 10
6	12	3666 06 12
8	10	3666 08 10
8	12	3666 08 12
8	14	3666 08 14
10	12	3666 10 12
10	14	3666 10 14
12	14	3666 12 14



plug-in increaser

3668

ØD1	ØD2	
6	4	3668 06 04



blanking plug

3626

ØD1	ØD2	
4	6	3626 04 00
6	8	3626 06 00
8	10	3626 08 00
10	12	3626 10 00
12	14	3626 12 00
14	16	3626 14 00



accessories and plugs

In order to offer **total connection** solutions, **Legris** provides users with a range of accessories and plugs, **suitable** for use with the different models featured in this Product Guide.

nickel-plated brass accessories

Designed to satisfy your requirements

0904



- enable **adaptation** to different types of female threads
- help to **minimise** stock holdings by limiting the number of part numbers to be used
- enhances the aesthetic appearance of installations
- optimised dimensions

straight male equal/unequal adapter

0900 0901



ØD	C	
R1/8	R1/8	0900 00 10
R1/4	R1/4	0900 00 13
R3/8	R3/8	0900 00 17
R1/2	R1/2	0900 00 21
R3/4	R3/4	0900 00 27
R1"	R1"	0900 00 34
R1/8	R1/4	0900 10 13
R1/8	R3/8	0900 10 17
R1/4	R3/8	0900 13 17
R1/4	R1/2	0900 13 21
R3/8	R1/2	0900 17 21
R1/2	R3/4	0900 21 27
R3/4	R1"	0900 27 34
M5x0,8	M5x0,8	0901 00 19
M5x0,8	G1/8"	0901 19 10

straight female, BSPP and M5 equal/unequal adapter

0902



ØD	C	
M5x0,8	M5x0,8	0902 00 19
G1/8	G1/8	0902 00 10
G1/4	G1/4	0902 00 13
G3/8	G3/8	0902 00 17
G1/2	G1/2	0902 00 21
G3/4	G3/4	0902 00 27

equal female stud elbow BSPP, male BSPT and M5 thread

0913



ØD	C	
G1/8	R1/8	0913 00 10
G1/4	R1/4	0913 00 13
G3/8	R3/8	0913 00 17
G1/2	R1/2	0913 00 21
G3/4	R3/4	0913 00 27

reducer male BSP taper to female BSP parallel

0904



ØD	C	
R1/4	G1/8	0904 10 13
R3/8	G1/8	0904 10 17
R3/8	G1/4	0904 13 17
R1/2	G1/4	0904 13 21
R1/2	G3/8	0904 17 21
R3/4	G3/8	0904 17 27
R3/4	G1/2	0904 21 27

equal female stud elbow, BSPP and M5 thread

0912



ØD	
M5x0,8	0912 00 19
G1/8	0912 00 10
G1/4	0912 00 13
G3/8	0912 00 17
G1/2	0912 00 21
G3/4	0912 00 27

equal male stud elbow, BSPP and M5 thread

0914



ØD	
R1/8	0914 00 10
R1/4	0914 00 13
R3/8	0914 00 17
R1/2	0914 00 21
R3/4	0914 00 27

equal female tee, BSPP and M5 thread

0915



ØD	
M5x0,8	0915 00 19
G1/8	0915 00 10
G1/4	0915 00 13
G3/8	0915 00 17
G1/2	0915 00 21
G3/4	0915 00 27

equal "Y" female BSPP thread

0910



ØD	
G1/8	0910 00 10
G1/4	0910 00 13
G3/8	0910 00 17
G1/2	0910 00 21

male stud branch tee, female BSPP, male BSPT

0916



ØD	C	
G1/8	R1/8	0916 00 10
G1/4	R1/4	0916 00 13
G3/8	R3/8	0916 00 17
G1/2	R1/2	0916 00 21
G3/4	R3/4	0916 00 27

equal female cross, BSPP thread

0908



ØD	
R1/8	0908 00 10
R1/4	0908 00 13
R3/8	0908 00 17
R1/2	0908 00 21
R3/4	0908 00 27

reducer male to female BSPP and M5 thread

0905



ØD	
G1/8	0905 00 10
G1/4	0905 00 13
G3/8	0905 00 17
G1/2	0905 00 21

equal extended adaptor male/female BSPP thread

0907



ØD	
G1/8	0907 00 10
G1/8	0907 00 10 01
G1/4	0907 00 13
G1/4	0907 00 13 01

tailpiece adaptor for rubber hose, male BSPP and M5 thread

0931



ØD	C	
6	G1/8	0931 06 10
6	G1/4	0931 06 13
7	G1/8	0931 07 10
7	G1/4	0931 07 13
7	G3/8	0931 07 17
8	G1/8	0931 08 10
8	G1/4	0931 08 13
8	G3/8	0931 08 17
10	G1/4	0931 10 13
10	G3/8	0931 10 17
10	G1/2	0931 10 21
15	G3/8	0931 15 17
15	G1/2	0931 15 21
18	G1/2	0931 18 21

female bulkhead connector, BSPP and M5

0920



C	C1	
M5x0,8	M10x1	0920 00 19
G1/8	M16x1,5	0920 00 10
G1/4	M20x1,5	0920 00 13
G3/8	M26x1,5	0920 00 17
G1/2	M28x1,5	0920 00 21

Technical specifications of nickel-plated brass accessories

working pressure : maximum 60 bar

working temperature : -10° to + 80°C

accessories and plugs

plugs

internal hexagon head
BSP taper

0205 C 

R1/8	0205 10 00
R1/4	0205 13 00
R3/8	0205 17 00
R1/2	0205 21 00
R3/4	0205 27 00
R1"	0205 34 00
R1"1/4	0205 42 00



brass

internal hexagon headed,
BSP taper

0285 ØD 

R1/8	0285 10 00
R1/4	0285 13 00
R3/8	0285 17 00
R1/2	0285 21 00
R3/4	0285 27 00



stainless steel 316L

sealing accessories

copper washers

0138 ØD C 

10	G1/8	0138 10 00
13	G1/4	0138 13 00
17	G3/8	0138 17 00
21	G1/2	0138 21 00
27	G3/4	0138 27 00
33	G1"	0138 33 00



fluoropolymer tape

0605 

0605 12 12



silencers

threaded silencer,
BSPP and M5 thread

0670 ØD 

G1/8	0670 00 10
G1/4	0670 00 13
G3/8	0670 00 17
G1/2	0670 00 21
G3/4	0670 00 27



sintered bronze

threaded silencer,
BSPP and M5 thread

0673 ØD 

G1/8	0673 00 10
G1/4	0673 00 13
G3/8	0673 00 17
M5x0,8	0673 00 19
G1/2	0673 00 21



brass and sintered bronze

flow control silencer,
BSPP thread

0672 ØD 

G1/8	0672 00 10
G1/4	0672 00 13
G3/8	0672 00 17
G1/2	0672 00 21



brass and sintered bronze

threaded silencer,
BSPP and M5 thread

0674 ØD 

M5x0,8	0674 00 19
G1/8	0674 00 10
G1/4	0674 00 13
G3/8	0674 00 17
G1/2	0674 00 21
G3/4	0674 00 27



polyethylen

threaded silencer,
BSPP thread

0682 ØD 

G1/8	0682 00 10
G1/4	0682 00 13
G3/8	0682 00 17
G1/2	0682 00 21
G3/4	0682 00 27



stainless steel 316L

Technical specifications of silencers

working pressure :

sintered bronze : 12 bar

polyethynene : 10 bar

stainless steel : 12 bar

working temperature :

-20° to + 150°C

-10° to + 80°C

-20° to + 180°C

aluminium anodised manifolds

female manifold
BSPP and M5 thread

3311 ØD C 

G1/8	M5x0,8	3311 19 10 07
G1/4	G1/8	3311 10 13 02
G1/4	G1/8	3311 10 13 03
G1/4	G1/8	3311 10 13 04
G1/4	G1/8	3311 10 13 05
G1/4	G1/8	3311 10 13 06
G3/8	G1/4	3311 13 17 02
G3/8	G1/4	3311 13 17 03
G3/8	G1/4	3311 13 17 04
G3/8	G1/4	3311 13 17 05
G3/8	G1/4	3311 13 17 06



female cross manifold
BSPP and M5 thread

3312 ØD 

M5x0,8	3312 00 19
G1/8	3312 00 10
G1/4	3312 00 13
G3/8	3312 00 17
G1/2	3312 00 21



double female manifold
BSPP thread

3313 ØD C 

G1/4	G1/8	3313 10 13 02
G1/4	G1/8	3313 10 13 03
G1/4	G1/8	3313 10 13 04
G1/4	G1/8	3313 10 13 05
G3/8	G1/4	3313 13 17 02
G3/8	G1/4	3313 13 17 03
G3/8	G1/4	3313 13 17 04
G3/8	G1/4	3313 13 17 05
G1/2	G1/4	3313 13 21 03
G1/2	G1/4	3313 13 21 04
G1/2	G1/4	3313 13 21 05



Technical specifications of aluminium anodised manifolds

working pressure : maximum 20 bar
working temperature : -10° to + 80°C

Stainless steel fittings : LF 3800 push-in fittings and function fittings



Applications

- designed for excellent resistance to aggressive/corrosive environments and fluids, these ranges are suitable for installation in many harsh and aggressive industrial applications.
- examples of LF 3800 applications : laboratories, medical sector, food and drinks processing, paint and printing industries.
- examples of flow control applications : pneumatic, food and pharmaceutical processing, semi-conductor industry.

Benefits

LF 3800 push-in fittings

- all stainless steel construction with FKM 'O' ring seals, they offer excellent resistance to aggressive fluids and environments
- allow instant manual connection and disconnection
- compact, they guarantee full bore fluid passage with minimal pressure drop
- multiple configurations
- allow connection with several types of Legris tubing shown in this Product guide : nylon tubing, polyurethane tubing, fluoropolymer FEP tubing and polyethylene tubing
- a range of stainless steel accessories in order to offer total connection solutions



Flow control regulators

- control the speed of a pneumatic cylinder in aggressive environments or submitted to high mechanical or chemical constraints.
- designed without bacterial retention zones, they provide excellent resistance to detergents and enables easy cleaning in a wide variety of application areas.
- working pressure : 1 to 10 bar
- working temperature : 0° to 70°C

Technical specifications

suitable fluids :
all fluids compatible with fitting and tubing materials

working pressure :
maximum 20 bar

working temperature :
- 15° to + 110°C

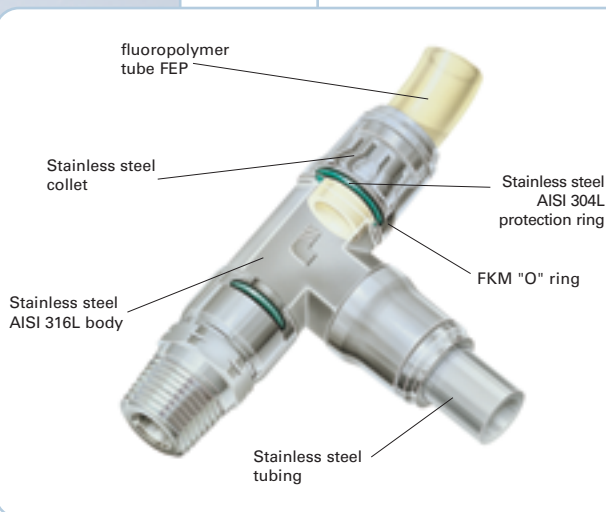

All items in the LF 3800 range are guaranteed **silicone free**.

maximum tightening torque for LF 3800 fittings, BSPP and metric threads

Thread	M5x0,8	G1/8"
da N.m	0,16	0,8

stainless steel LF 3800 push-in fittings and function fittings

Designed to satisfy your requirements

3821



- with this male stud standpipe, tees and elbows can be fitted where required

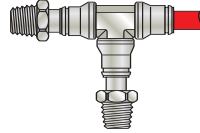

- by using this product, stock of parts may be reduced
- available for metric or imperial tube with BSPT or NPT threads

male stud, BSPT, BSPP and metric thread

3805



ØD	C	
4	R1/8	3805 04 10
4	R1/4	3805 04 13
6	R1/8	3805 06 10
6	R1/4	3805 06 13
8	R1/8	3805 08 10
8	R1/4	3805 08 13
8	R3/8	3805 08 17
10	R1/4	3805 10 13
10	R3/8	3805 10 17
12	R1/4	3805 12 13
12	R3/8	3805 12 17
12	R1/2	3805 12 21

3801



ØD	C	
4	M5x0,8	3801 04 19
4	G1/8	3801 04 10

male stud standpipe, BSPT thread

3821



ØD	C	
4	R1/8	3821 04 10
6	R1/8	3821 06 10
6	R1/4	3821 06 13
8	R1/8	3821 08 10
8	R1/4	3821 08 13
10	R1/4	3821 10 13
10	R3/8	3821 10 17
12	R1/4	3821 12 13
12	R3/8	3821 12 17
12	R1/2	3821 12 21

male stud elbow, BSPT and metric thread

3809



ØD	C	
4	R1/8	3809 04 10
6	R1/8	3809 06 10
6	R1/4	3809 06 13
8	R1/8	3809 08 10
8	R1/4	3809 08 13
10	R1/4	3809 10 13
10	R3/8	3809 10 17

3899



ØD	C	
4	M5x0,8	3899 04 19

compact male stud elbow, BSPT thread

3889



ØD	C	
4	R1/8	3889 04 10
4	R1/4	3889 04 13
6	R1/8	3889 06 10
6	R1/4	3889 06 13
8	R1/8	3889 08 10
8	R1/4	3889 08 13
10	R1/4	3889 10 13
10	R3/8	3889 10 17
12	R1/4	3889 12 13
12	R3/8	3889 12 17
12	R1/2	3889 12 21

equal elbow

3802



ØD	
4	3802 04 00
6	3802 06 00
8	3802 08 00
10	3802 10 00
12	3802 12 00

equal straight connector

3806



ØD	
4	3806 04 00
6	3806 06 00
8	3806 08 00
10	3806 10 00
12	3806 12 00

equal tee

3804



ØD	
4	3804 04 00
6	3804 06 00
8	3804 08 00
10	3804 10 00
12	3804 12 00

equal bulkhead connector

3816



ØD	
4	3816 04 00
6	3816 06 00
8	3816 08 00
10	3816 10 00
12	3816 12 00

push-in reducer

3866



ØD	
4	6 3866 04 06
4	8 3866 04 08
6	8 3866 06 08
6	10 3866 06 10
8	10 3866 08 10
8	12 3866 08 12
10	12 3866 10 12

flow control regulators

with threaded fitting, BSPP and metric – recessed adjustment screw



7810



C1-C2	
G1/8	7810 10 10
G1/4	7810 13 13
G3/8	7810 17 17
G1/2	7810 21 21

for pneumatic applications

with threaded fitting, BSPP and metric – recessed adjustment screw



7812



C1-C2	
G1/8	7812 10 10
G1/4	7812 13 13
G3/8	7812 17 17
M5x0,8	7812 19 19
G1/2	7812 21 21

for pneumatic applications

non-return valves

unidirectional, female-female, BSPP thread



4890



C	DN	
G1/8	10	4890 10 10
G1/4	10	4890 13 13
G3/8	15	4890 17 17
G1/2	15	4890 21 21
G3/4	20	4890 27 27
G1"	25	4890 34 34

working pressure : 0,5 to 40 bar
 working temperature : -20° to +180°C
 materials :
 - body : stainless steel
 - 'O' ring seals : FKM

stainless steel accessories

equal elbow,
female BSPP thread

1843 C 

G1/8	1843 10 10
G1/4	1843 13 13
G3/8	1843 17 17
G1/2	1843 21 21



equal tee,
triple female BSPP thread

1845 C 

G1/8	1845 10 10
G1/4	1845 13 13
G3/8	1845 17 17
G1/2	1845 21 21



double female sleeve,
BSPP thread

1855 C 

G1/8	1855 10 10
G1/4	1855 13 13
G3/8	1855 17 17
G1/2	1855 21 21



bulkhead adaptor,
BSPP thread

1817 C 

G1/8	1817 00 10
G1/4	1817 00 13
G3/8	1817 00 17
G1/2	1817 00 21



reducer/increaser double female
sleeve, BSPP thread

1862 C1 C2 

G1/4	G1/8	1862 13 10
G3/8	G1/8	1862 17 10
G3/8	G1/4	1862 17 13
G1/2	G1/4	1862 21 13
G1/2	G3/8	1862 21 17



male NPT to female
BSPP adapter

1864 C1 C2 

1/8	G1/8	1864 11 10
1/4	G1/4	1864 14 13
3/8	G3/8	1864 18 17
1/2	G1/2	1864 22 21



male BSPT to female
NPT adaptor

1867 C1 C2 

R1/8	1/8	1867 10 11
R1/4	1/4	1867 13 14
R3/8	3/8	1867 17 18
R1/2	1/2	1867 21 22



reducer male BSPT to female
BSPP

1863 C1 C2 

R1/4	G1/8	1863 13 10
R3/8	G1/8	1863 17 10
R3/8	G1/4	1863 17 13
R1/2	G1/4	1863 21 13
R1/2	G3/8	1863 21 17



straight male
BSPT equal/unequal adaptor

1821 C1 C2 

R1/8	R1/8	1821 10 10
R1/4	R1/8	1821 13 10
R1/4	R1/4	1821 13 13
R3/8	R1/4	1821 17 13
R3/8	R3/8	1821 17 17
R1/2	R3/8	1821 21 17
R1/2	R1/2	1821 21 21



tailpiece adaptor for rubber hose,
male NPT

1823 ØD C 

7	R1/8	1823 07 10
7	R1/4	1823 07 13
10	R1/4	1823 10 13
10	R3/8	1823 10 17
13	R3/8	1823 13 17
16	R1/2	1823 16 21



internal hexagon headed,
BSP taper

0285 

ØD	
R1/8	0285 10 00
R1/4	0285 13 00
R3/8	0285 17 00
R1/2	0285 21 00
R3/4	0285 27 00



threaded silencer,
BSPP thread

0682 

ØD	
G1/8	0682 00 10
G1/4	0682 00 13
G3/8	0682 00 17
G1/2	0682 00 21
G3/4	0682 00 27



ferrule for plastic and
fluoropolymer tubing

1827 ØD1 ØD2 

ØD1	6	4	1827 06 00
	8	6	1827 08 00
	10	8	1827 10 00
	12	10	1827 12 00
	16	14	1827 16 00



ØD2

This ferrule is necessary when using nylon, polyethylene and fluoropolymer FEP tubing at all temperatures compatible with the fitting/tube assembly.





Technical tubes and hoses

Applications





The extensive compatibility of Legris fittings/technical tubes and hoses is ideally suited for **many industrial and food applications**. Legris' policy is to be able to offer its customers a **full range** of tubes and hoses, compatible with the different ranges of fittings featured in this product guide.

The overview below illustrates the **best choices** to obtain the **best performance** of the fitting/tube connection.

Nylon tubing



	connections	applications
semi-rigid 	LF 3000®, LF 3600, LF 3800 push-in fittings  adaptors 	pneumatic systems 
benefits : <ul style="list-style-type: none"> - large range of working temperatures and pressures - good chemical resistance - 7 colours for easy identification of circuits - close tolerance, 3 mm to 16 mm 		

Polyurethane tubing





	connections	applications
polyester 	LF 3000®, LF 3600, LF 3800 push-in fittings  adaptors 	pneumatic systems 
benefits : <ul style="list-style-type: none"> - large range of working temperatures and pressures - high flexibility - good chemical resistance - 6 colours for easy identification of circuits - close tolerance, 4 mm to 14 mm 		

Fluoropolymer FEP tube







	connections	applications
	LF 3600, LF 3800 push-in fittings 	food industry and aggressive environment 
benefits : <ul style="list-style-type: none"> - excellent resistance to chemicals and high temperature - food quality - close tolerance, 4 mm to 12 mm 		

Recoil tubing

	connections	applications
polyurethane with integral 1/4" BSP taper fitting 	C 9000 and metal quick acting couplers  Blowguns 	pneumatic equipment 
benefits : <ul style="list-style-type: none"> - the coil will continue to contract after multiple use - high flexibility - good chemical resistance - 3 colours - 4 mm to 12 mm o.d. 		

Braided PVC hose



	connections	applications
	adaptors  C 9000 and metal quick acting couplers 	suitable for use with food and industrial fluids 
benefits : <ul style="list-style-type: none"> - translucent for visual checking of fluid - food quality - 8 mm to 26 mm o.d. 		



In order to obtain the best performance of the fitting/tube connection, the technical specifications of each component should be taken into account by the user.

 = suitable for food applications



technical tubes and hoses

close tolerance semi-rigid nylon tubing

1025P close tolerance semi-rigid nylon tubing, 25 m rolls



o.d. tube mm	i.d. tube mm	R minimum bend radius for tube at ambient temp. in mm			
4	2,7	30	1025P04 00 27	1025P04 01 27	1025P04 04 27
6	4	35	1025P06 00	1025P06 01	1025P06 04
8	6	55	1025P08 00	1025P08 01	1025P08 04
10	7,5	75	1025P10 00 75	1025P10 01 75	1025P10 04 75
12	9	75	1025P12 00 09	1025P12 01 09	1025P12 04 09
14	11	120	1025P14 00 11	1025P14 01 11	1025P14 04 11

1100P close tolerance semi-rigid nylon tubing, 100 m rolls



o.d. tube mm	i.d. tube mm	R minimum bend radius for tube at ambient temp. in mm			
4	2,7	30	1100P04 00 27	1100P04 01 27	1100P04 04 27
6	4	35	1100P06 00	1100P06 01	1100P06 04
8	6	55	1100P08 00	1100P08 01	1100P08 04
10	7,5	75	1100P10 00 75	1100P10 01 75	

close tolerance flexible polyurethane tubing

1025U close tolerance flexible polyurethane tubing, 25 m rolls

o.d. tube mm	i.d. tube mm	R minimum bend radius for tube at ambient temp. in mm	 polyester	 polyester	 polyether crystal
4	2,5	10	1025U04 01	1025U04 04	1025U04R08
6	4	15	1025U06 01	1025U06 04	1025U06R08
8	5,5	20	1025U08 01	1025U08 04	1025U08R08
10	7	25	1025U10 01	1025U10 04	1025U10R08
12	8	35	1025U12 01		1025U12R08
14	9,5	45	1025U14 01 95		1025U14R08 95



1100U close tolerance flexible polyurethane tubing, 100 m rolls

o.d. tube mm	i.d. tube mm	R minimum bend radius for tube at ambient temp. in mm	 polyester	 polyester
4	2,5	10	1100U04 01	1100U04 04
6	4	15	1100U06 01	1100U06 04
8	5,5	20	1100U08 01	1100U08 04

close tolerance fluoropolymer FEP tube





 = suitable for food applications





1005T - 1025T





o.d. tube mm	i.d. tube mm	R minimum bend radius for tube at ambient temp. in mm	in 5 m rolls white 	in 25 m rolls white 
4	2,5	40	1005T04 00 25	1025T04 00 25
6	4	50	1005T06 00	1025T06 00
8	6	70	1005T08 00	1025T08 00
10	8	120	1005T10 00	1025T10 00
12	10	180	1005T12 00	1025T12 00

technical tubes and hoses

close tolerance polyester polyurethane recoil tubing

1470U polyester polyurethane recoil tubing, 2 m long, with BSPT thread connections									
o.d. tube mm	i.d. tube mm	BSPT thread					length of long straight section in mm	length of short straight section in mm	
8	5	R1/4	1470U08 03 13	1470U08 04 13	1470U08 05 13	190	500	100	42

1471U polyester polyurethane recoil tubing, 4 m long, with BSPT thread connections									
o.d. tube mm	i.d. tube mm	BSPT thread					length of long straight section in mm	length of short straight section in mm	
8	5	R1/4	1471U08 03 13	1471U08 04 13	1471U08 05 13	400	500	100	42

1472U polyester polyurethane recoil tubing, 6 m long, with BSPT thread connections									
o.d. tube mm	i.d. tube mm	BSPT thread					length of long straight section in mm	length of short straight section in mm	
8	5	R1/4	1472U08 03 13	1472U08 04 13	1472U08 05 13	650	500	100	42



braided PVC hose

 = suitable for food applications

1025V			in 25 m rolls white
o.d. tube mm	i.d. tube mm	R minimum bend radius for tube at ambient temp. in mm	
11	6	12	1025V11 00 06
14	8	16	1025V14 00 08
16	10	25	1025V16 00 10

accessories

clip strips for tubes

Clip	ØD	
	4	Clip 04 00
	6	Clip 06 00
	8	Clip 08 00
	10	Clip 10 00
	12	Clip 12 00
	14	Clip 14 00

Delivered in boxes of 10 strips of the same diameter (complete with self-tapping screws of 9.5 mm length).

tube cutter

3000 71 00	
	3000 71 00

This tool will cut all resilient plastic tube (nylon, FEP, polyurethane, braided PVC) from 4mm to 14mm diameter inclusive. It is designed to give a clean cut at right angles to the tube axis. A spring maintains the cutter in the closed position.

clip for PVC braided tube

0697	ØD	
	8	0697 00 01
	10	0697 00 02
	11	0697 00 02
	13	0697 00 02
	15	0697 00 03
	18	0697 00 03
	21	0697 00 04
	26	0697 00 05

Quick acting couplers



Applications

- for installations which require **frequent connection** or **disconnection** whether two hoses or a single hose and connection point.
- suitable for **all applications** and **equipment** working with **compressed air** and **vacuum** (metal quick acting couplers). For examples : pneumatic tools, pneumatic automation equipment, etc.



Benefits

Polymer C 9000 quick acting safety couplers

- **100% safety** : even if disconnection is performed rapidly, the safety of the end-users is guaranteed thanks to a very short vent-time. Comply with **ISO 4414** and **EN 983** safety standards.
- very high **flow** and extremely small pressure loss
- perfectly controlled **sealing**
- **high impact** composite material **resistant** to shocks and scratching
- excellent **mechanical strength** : extending lifetime performance and reliability
- virtually **effortless** connection and disconnection



Metal quick acting couplers

- flow capacities from 165 NI/min to 3500 NI/min
- a complete range for water, compressed air and vacuum
- manufactured with **robust** material
- **easy** to install : automatic connection, with one hand, and instant disconnection by simply pulling back the sleeve
- maximum working pressure : **35 bar**
- **vacuum** capability

Technical specifications

Polymer C 9000 quick acting safety couplers

- suitable fluid** : compressed air
- working pressure** : 0 to 16 bar
- working temperature** : - 20° to + 60°C

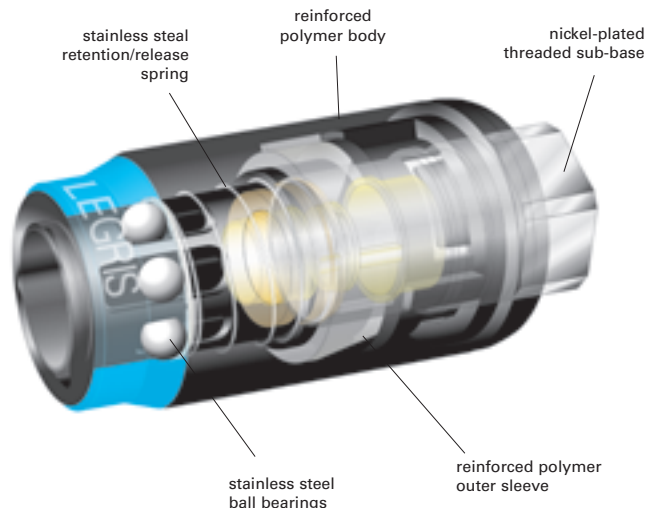

quick acting couplers

C9000 Advanced quick acting safety couplers

male body,
BSPT thread

female body,
BSPP thread

body with hosetail

9405U ØD
R1/4 9405U06 13
R3/8 9405U06 17



9414U ØD
G1/4 9414U06 13
G3/8 9414U06 17

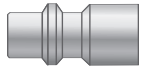

9421U ØD
6 9421U06 06
8 9421U06 08

ISO B6

Flow : 1 250 NI/min
Passage : 5,5 mm

Safety



male thread,
BSPP thread

female thread,
BSPP thread

probe with hosetail

9087U ØD
G1/4 9087U06 13
G3/8 9087U06 17



9086U ØD
G1/4 9086 23 13
G3/8 9086 23 17



9094U ØD
6 9094U06 06
8 9094U06 08
10 9094U06 10



Nickel plated brass quick acting couplers

Series 24

male body,
BSPP thread

female body,
BSPP thread

body with barbed fitting

9101 ØD
G1/4 9101 24 13
G3/8 9101 24 17



9114 ØD
G1/4 9114 24 13
G3/8 9114 24 17

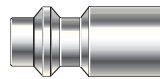

9123 ØD
6 9123 24 06
8 9123 24 08
10 9123 24 10

Flow : 800 NI/min
Passage : 5,5 mm

Single shut-off



male thread,
BSPP thread

female thread,
BSPP thread

probe with hosetail

9087 ØD
G1/4 9087U06 13
G3/8 9087U06 17



9086 ØD
G1/4 9086 23 13
G3/8 9086 23 17



9085 ØD
6 9085 23 06
8 9085 23 08
10 9085 23 10



Blowguns

standard blowgun
with angled nozzle

lever operated nickel plated brass
air gun with removable nozzle

0659 C  
G1/4 3,5 0659 00 13



0623 C  
G1/4 2 0623 10 35



Industrial ball valves and axial valves

These **Legris ball valves** are suited to a variety of customer requirements in terms of performance.

- **nickel-plated brass ball valves, fluoropolymer series**
economical solution, with full flow fluid passage, they are adapted to many applications requiring PTFE seals.
- **stainless steel ball valves**
designed for use with **corrosive fluids** and in **aggressive environments**, they are suited to high pressure and high temperature industrial applications.
- **nickel-plated brass lockable ball valves**
designed for **safety of personnel and equipment**, they allow to prevent potentially dangerous consequences caused by unintended operations.

- The **axial valves** offer the functions of a valve fitted with an actuator. A pneumatic automation device is fitted directly into the valve. Its operation is not affected by the up/downstream pressures of the transported fluids, which guarantees the user total safety and a vastly simplified choice.

nickel-plated brass ball valves

fluoropolymer series

double female with standard handle, BSP parallel

4905

C	DN	PN	
G1/4	10	25	4905 00 13
G3/8	10	25	4905 00 17
G1/2	15	25	4905 00 21
G3/4	20	25	4905 00 27
G1"	25	25	4905 00 34
G1 1/4"	32	16	4905 00 42
G1 1/2"	40	16	4905 00 49
G2"	50	16	4905 00 48



Working temperature : -20° to +90°C

Maximum working pressure :

- G1/4 to G1" : 25 bar
- G1 1/4" to G2" : 16 bar

double female with butterfly handle, BSP parallel

4906

C	DN	PN	
G1/4	10	25	4906 00 13
G3/8	10	25	4906 00 17
G1/2	15	25	4906 00 21
G3/4	20	25	4906 00 27
G1"	25	25	4906 00 34



Working temperature : -20° to +90°C

Maximum working pressure :

- G1/4 to G1" : 25 bar

lockable ball valves

double female with vent

0439

C	DN	
G1/4	7	0439 07 13
G3/8	10	0439 10 17
G1/2	13	0439 13 21



Working temperature : -20° to +80°C

Maximum working pressure : 40 bar

handle is non-removeable.

light series ball valve

double female

0492

C	DN	
G1/4	4	0492 04 13
G1/4	4	0492 04 13 64*
G3/8	7	0492 07 17
G1/2	10	0492 10 21
G3/4	13	0492 13 27



* Zamac short handle

male and female

0491

C	DN	
G1/4	4	0491 04 13
G1/4	4	0491 04 13 64*
G3/8	7	0491 07 17
G1/2	10	0491 10 21
G3/4	13	0491 13 27



* Zamac short handle

stainless steel ball valves

double female, economy version, BSP parallel

4810

C	DN	
G1/4	8	4810 08 13
G3/8	10	4810 10 17
G1/2	15	4810 15 21
G3/4	20	4810 20 27
G1"	25	4810 25 34



Threads conform to ISO 228-1.

axial valves

normally closed, double female BSPP thread

4202

C	DN	
G3/8	10	4202 10 17 20
G1/2	15	4202 15 21 20
G3/4	20	4202 20 27 20
G1"	25	4202 25 34 20
G1 1/4"	32	4202 32 42 20
G1 1/2"	40	4202 40 49 20
G2"	50	4202 50 48 20



subbase for solenoid valve

4298

C	
M5x0,8	4298 00 01



Technical specifications

Suitable fluids : water, air, oils greases ...

Working temperature : - 20° to + 135°C

Working pressure : 10 bar

Pilot fluid : filtered compressed air

Pilot pressure :

- NC and NO : 4,2 to 8 bar

- Double acting : 3 to 8 bar

Leader in industrial connectics, Legris develops an offer of technical components for fluid circuits and innovative services for its customers.



Legris Connectic : a full range of high and low pressure fittings, couplers, tubes, valves and accessories.



Legris Transair : the Transair range of quick connections for compressed air systems and cooling circuits.

For more information, connect up to Legris web-site.

www.legris.com